

SOP- 8 LOW DROPOUT LINEAR REGULATOR

LJ1117 Series

Features

- Low Dropout Voltage: 1.15V at 1A Output Current
- Trimmed Current Limit
- On-chip Thermal Shutdown
- Three-terminal Adjustable or Fixed 1.2V, 1.5V, 1.8V, 2.5V, 3.3V, 5.0V
- Operation Junction Temperature: -40 to 125°C

Applications

- PC Motherboard
- LCD Monitor
- Graphic Card
- DVD-video Player
- NIC/Switch
- Telecom Equipment
- ADSL Modem
- Printer and other Peripheral Equipment

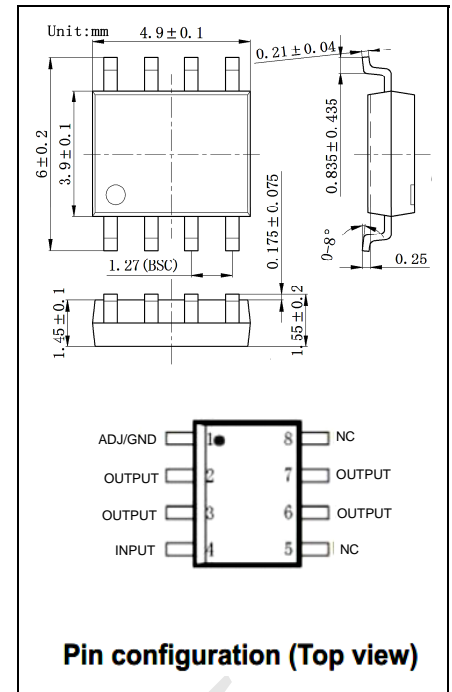

Absolute Maximum Ratings (Note 1)

Symbol	Parameter	Min	Max	Unit
V _{IN}	Input Voltage		20	V
T _J	Maximum Junction Temperature		150	°C
T _S	Storage Temperature	-65	150	°C
T _{LEAD}	Lead Temperature (Soldering, 10sec)		300	°C
ESD	ESD (Machine Model)		600	V

Note 1: Stresses greater than those listed under "Absolute Maximum Ratings" may cause permanent damage to the device. These are stress ratings only, and functional operation of the device at these or any other conditions beyond those indicated under "Recommended Operating Conditions" is not implied. Exposure to "Absolute Maximum Ratings" for extended periods may affect device reliability.

Recommended Operating Conditions

Symbol	Parameter	Min	Max	Unit
V _{IN}	Input Voltage		15	V
T _J	Operating Junction Temperature Range	-40	125	°C

Functional Block Diagram

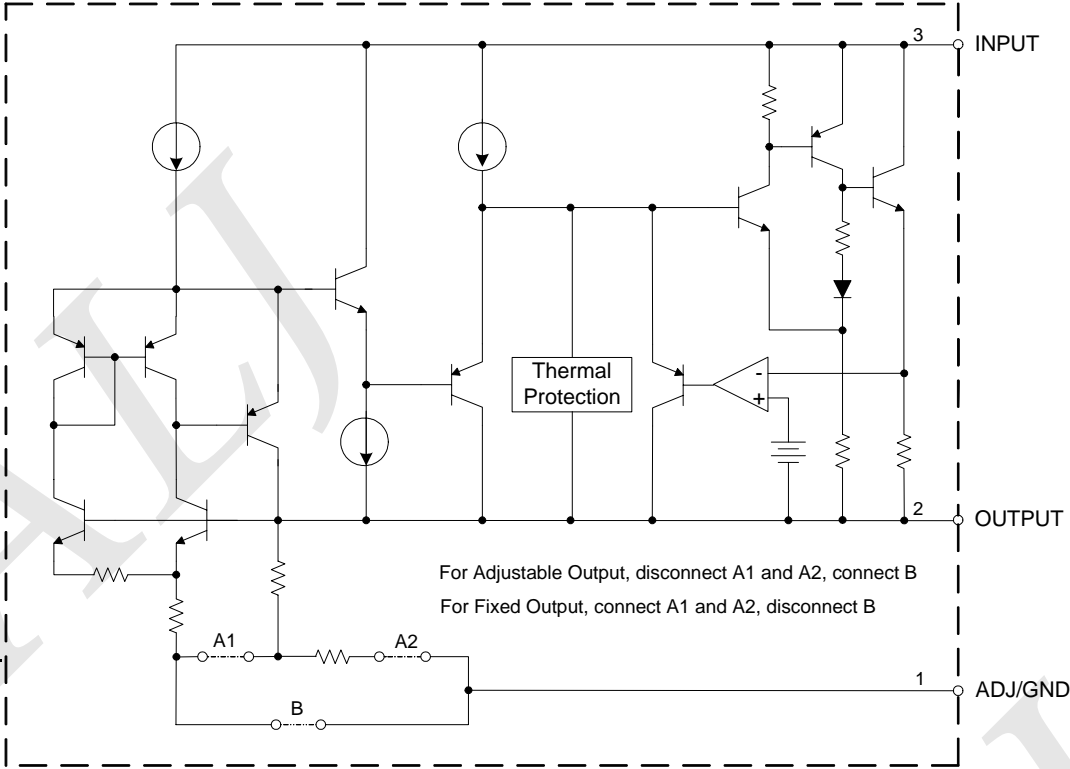

Figure 1. Functional Block Diagram of LJ1117

LJ1117-ADJ Electrical Characteristics

Operating Conditions: $V_{IN} \leq 10V$, $T_J = 25^\circ C$, unless otherwise specified.

Symbol	Parameter	Conditions	Min	Typ	Max	Unit
V_{REF}	Reference Voltage	$I_{OUT} = 10mA$, $V_{IN} - V_{OUT} = 2V$ $10mA \leq I_{OUT} \leq 1A$, $1.4V \leq V_{IN} - V_{OUT} \leq 8V$, $P \leq$ Maximum Power Dissipation	1.238 1.225	1.250 1.250	1.262 1.270	V
ΔV_{OUT}	Line Regulation	$I_{OUT} = 10mA$, $1.5V \leq V_{IN} - V_{OUT} \leq 10V$		0.035	0.2	%
ΔV_{OUT}	Load Regulation	$V_{IN} - V_{OUT} = 2V$, $10mA \leq I_{OUT} \leq 1A$		0.2	0.4	%
	Dropout Voltage	$\Delta V_{REF} = 1\%$, $I_{OUT} = 0.1A$		1.00	1.1	V
		$\Delta V_{REF} = 1\%$, $I_{OUT} = 0.5A$		1.08	1.18	V
		$\Delta V_{REF} = 1\%$, $I_{OUT} = 1.0A$		1.15	1.25	V
I_{LIMIT}	Current Limit	$V_{IN} - V_{OUT} = 2V$	1.25	1.35		A
	Adjust Pin Current			60	120	μA
	Adjust Pin Current Change	$1.4V \leq V_{IN} - V_{OUT} \leq 10V$, $10mA \leq I_{OUT} \leq 1A$		0.2	5	μA
	Minimum Load Current (ADJ)	$1.5V \leq V_{IN} - V_{OUT} \leq 10V$ (ADJ only)		1.7	5	mA
	Quiescent Current	$V_{IN} = V_{OUT} + 1.25V$		5	10	mA
	Ripple Rejection	$f = 120Hz$, $C_{OUT} = 22\mu F$ Tantalum, $V_{IN} - V_{OUT} = 3V$, $I_{OUT} = 1A$	60	75		dB
	Temperature Stability			0.5		%
	Long -Term Stability	$T_A = 125^\circ C$, 1000hrs		0.3		%
	RMS Output Noise (% of V_{OUT})	$T_A = 25^\circ C$, $10Hz \leq f \leq 10kHz$		0.003		%
θ_{JC}	Thermal Resistance, Junction to Case			15		$^\circ C/W$
	Thermal Shutdown	Junction Temperature		150		$^\circ C$
	Thermal Shutdown Hysteresis			25		$^\circ C$

LJ1117-1.2V Electrical Characteristics

Operating Conditions: $V_{IN} \leq 10V$, $T_J = 25^\circ C$, unless otherwise specified.

Symbol	Parameter	Conditions	Min	Typ	Max	Unit
V_{OUT}	Output Voltage	$I_{OUT} = 10mA$, $V_{IN} = 3.2V$ $10mA \leq I_{OUT} \leq 1A$, $3.0V \leq V_{IN} \leq 10V$	1.176 1.152	1.2 1.2	1.224 1.248	V
ΔV_{OUT}	Line Regulation	$I_{OUT} = 10mA$, $1.5V \leq V_{IN} - V_{OUT} \leq 10V$		1	6	mV
ΔV_{OUT}	Load Regulation	$V_{IN} - V_{OUT} = 2V$, $10mA \leq I_{OUT} \leq 1A$		1	10	mV
	Dropout Voltage	$\Delta V_{OUT} = 1\%$, $I_{OUT} = 0.1A$		1.00	1.1	V
		$\Delta V_{OUT} = 1\%$, $I_{OUT} = 0.5A$		1.08	1.18	V
		$\Delta V_{OUT} = 1\%$, $I_{OUT} = 1.0A$		1.15	1.25	V
I_{LIMIT}	Current Limit	$V_{IN} - V_{OUT} = 2V$	1.25	1.35		A
	Quiescent Current	$V_{IN} = V_{OUT} + 1.25V$		5	10	mA
	Ripple Rejection	$f = 120Hz$, $C_{OUT} = 22\mu F$ Tantalum, $V_{IN} - V_{OUT} = 3V$, $I_{OUT} = 1A$	60	75		dB
	Temperature Stability			0.5		%
	Long -Term Stability	$T_A = 125^\circ C$, 1000hrs		0.3		%
	RMS Output Noise (% of V_{OUT})	$T_A = 25^\circ C$, $10Hz \leq f \leq 10kHz$		0.003		%
θ_{JC}	Thermal Resistance, Junction to Case			15		$^\circ C/W$
	Thermal Shutdown	Junction Temperature		150		$^\circ C$
	Thermal Shutdown Hysteresis			25		$^\circ C$

LJ1117-1.5V Electrical Characteristics

Operating Conditions: $V_{IN} \leq 10V$, $T_J = 25^\circ C$, unless otherwise specified.

Symbol	Parameter	Conditions	Min	Typ	Max	Unit
V_{OUT}	Output Voltage	$I_{OUT} = 10mA$, $V_{IN} = 3.5V$ $10mA \leq I_{OUT} \leq 1A$, $3.0V \leq V_{IN} \leq 10V$	1.485 1.470	1.5 1.5	1.515 1.530	V
ΔV_{OUT}	Line Regulation	$I_{OUT} = 10mA$, $1.5V \leq V_{IN} - V_{OUT} \leq 10V$		1	6	mV
ΔV_{OUT}	Load Regulation	$V_{IN} - V_{OUT} = 2V$, $10mA \leq I_{OUT} \leq 1A$		1	10	mV
	Dropout Voltage	$\Delta V_{OUT} = 1\%$, $I_{OUT} = 0.1A$		1.00	1.1	V
		$\Delta V_{OUT} = 1\%$, $I_{OUT} = 0.5A$		1.08	1.18	V
		$\Delta V_{OUT} = 1\%$, $I_{OUT} = 1.0A$		1.15	1.25	V
I_{LIMIT}	Current Limit	$V_{IN} - V_{OUT} = 2V$	1.25	1.35		A
	Quiescent Current	$V_{IN} = V_{OUT} + 1.25V$		5	10	mA
	Ripple Rejection	$f = 120Hz$, $C_{OUT} = 22\mu F$ Tantalum, $V_{IN} - V_{OUT} = 3V$, $I_{OUT} = 1A$	60	75		dB
	Temperature Stability			0.5		%
	Long -Term Stability	$T_A = 125^\circ C$, 1000hrs		0.3		%
	RMS Output Noise (% of V_{OUT})	$T_A = 25^\circ C$, $10Hz \leq f \leq 10kHz$		0.003		%
θ_{JC}	Thermal Resistance, Junction to Case			15		$^\circ C/W$
	Thermal Shutdown	Junction Temperature		150		$^\circ C$
	Thermal Shutdown Hysteresis			25		$^\circ C$

LJ1117-1.8V Electrical Characteristics

Operating Conditions: $V_{IN} \leq 10V$, $T_j = 25^\circ C$, unless otherwise specified.

Symbol	Parameter	Conditions	Min	Typ	Max	Unit
V_{OUT}	Output Voltage	$I_{OUT} = 10mA$, $V_{IN} = 3.8V$ $10mA \leq I_{OUT} \leq 1A$, $3.2V \leq V_{IN} \leq 10V$	1.782 1.746	1.8 1.8	1.818 1.854	V
ΔV_{OUT}	Line Regulation	$I_{OUT} = 10mA$, $1.5V \leq V_{IN} - V_{OUT} \leq 10V$		1	6	mV
ΔV_{OUT}	Load Regulation	$V_{IN} - V_{OUT} = 2V$, $10mA \leq I_{OUT} \leq 1A$		1	10	mV
	Dropout Voltage	$\Delta V_{OUT} = 1\%$, $I_{OUT} = 0.1A$		1.00	1.1	V
		$\Delta V_{OUT} = 1\%$, $I_{OUT} = 0.5A$		1.08	1.18	V
		$\Delta V_{OUT} = 1\%$, $I_{OUT} = 1.0A$		1.15	1.25	V
I_{LIMIT}	Current Limit	$V_{IN} - V_{OUT} = 2V$	1.25	1.35		A
	Quiescent Current	$V_{IN} = V_{OUT} + 1.25V$		5	10	mA
	Ripple Rejection	$f = 120Hz$, $C_{OUT} = 22\mu F$ Tantalum, $V_{IN} - V_{OUT} = 3V$, $I_{OUT} = 1A$	60	75		dB
	Temperature Stability			0.5		%
	Long -Term Stability	$T_A = 125^\circ C$, 1000hrs		0.3		%
	RMS Output Noise (% of V_{OUT})	$T_A = 25^\circ C$, $10Hz \leq f \leq 10kHz$		0.003		%
θ_{JC}	Thermal Resistance, Junction to Case			15		$^\circ C/W$
	Thermal Shutdown	Junction Temperature		150		$^\circ C$
	Thermal Shutdown Hysteresis			25		$^\circ C$

LJ1117-2.5V Electrical Characteristics

Operating Conditions: $V_{IN} \leq 10V$, $T_J = 25^\circ C$, unless otherwise specified.

Symbol	Parameter	Conditions	Min	Typ	Max	Unit
V_{OUT}	Output Voltage	$I_{OUT} = 10mA$, $V_{IN} = 4.5V$ $10mA \leq I_{OUT} \leq 1A$, $3.9V \leq V_{IN} \leq 10V$	2.475 2.450	2.5 2.5	2.525 2.550	V
ΔV_{OUT}	Line Regulation	$I_{OUT} = 10mA$, $1.5V \leq V_{IN} - V_{OUT} \leq 10V$		1	6	mV
ΔV_{OUT}	Load Regulation	$V_{IN} - V_{OUT} = 2V$, $10mA \leq I_{OUT} \leq 1A$		1	10	mV
	Dropout Voltage	$\Delta V_{OUT} = 1\%$, $I_{OUT} = 0.1A$		1.00	1.1	V
		$\Delta V_{OUT} = 1\%$, $I_{OUT} = 0.5A$		1.08	1.18	V
		$\Delta V_{OUT} = 1\%$, $I_{OUT} = 1.0A$		1.15	1.25	V
I_{LIMIT}	Current Limit	$V_{IN} - V_{OUT} = 2V$	1.25	1.35		A
	Quiescent Current	$V_{IN} = V_{OUT} + 1.25V$		5	10	mA
	Ripple Rejection	$f = 120Hz$, $C_{OUT} = 22\mu F$ Tantalum, $V_{IN} - V_{OUT} = 3V$, $I_{OUT} = 1A$	60	75		dB
	Temperature Stability			0.5		%
	Long -Term Stability	$T_A = 125^\circ C$, 1000hrs		0.3		%
	RMS Output Noise (% of V_{OUT})	$T_A = 25^\circ C$, $10Hz \leq f \leq 10kHz$		0.003		%
θ_{JC}	Thermal Resistance, Junction to Case			15		$^\circ C/W$
	Thermal Shutdown	Junction Temperature		150		$^\circ C$
	Thermal Shutdown Hysteresis			25		$^\circ C$

LJ1117-3.3V Electrical Characteristics

Operating Conditions: $V_{IN} \leq 10V$, $T_J = 25^\circ C$, unless otherwise specified.

Symbol	Parameter	Conditions	Min	Typ	Max	Unit
V_{OUT}	Output Voltage	$I_{OUT} = 10mA$, $V_{IN} = 5.0V$ $10mA \leq I_{OUT} \leq 1A$, $4.75V \leq V_{IN} \leq 10V$	3.267 3.235	3.3 3.3	3.333 3.365	V
ΔV_{OUT}	Line Regulation	$I_{OUT} = 10mA$, $1.5V \leq V_{IN} - V_{OUT} \leq 10V$		1	6	mV
ΔV_{OUT}	Load Regulation	$V_{IN} - V_{OUT} = 2V$, $10mA \leq I_{OUT} \leq 1A$		1	10	mV
	Dropout Voltage	$\Delta V_{OUT} = 1\%$, $I_{OUT} = 0.1A$		1.00	1.1	V
		$\Delta V_{OUT} = 1\%$, $I_{OUT} = 0.5A$		1.08	1.18	V
		$\Delta V_{OUT} = 1\%$, $I_{OUT} = 1.0A$		1.15	1.25	V
I_{LIMIT}	Current Limit	$V_{IN} - V_{OUT} = 2V$	1.25	1.35		A
	Quiescent Current	$V_{IN} = V_{OUT} + 1.25V$		5	10	mA
	Ripple Rejection	$f = 120Hz$, $C_{OUT} = 22\mu F$ Tantalum, $V_{IN} - V_{OUT} = 3V$, $I_{OUT} = 1A$	60	75		dB
	Temperature Stability			0.5		%
	Long -Term Stability	$T_A = 125^\circ C$, 1000hrs		0.3		%
	RMS Output Noise (% of V_{OUT})	$T_A = 25^\circ C$, $10Hz \leq f \leq 10kHz$		0.003		%
θ_{JC}	Thermal Resistance, Junction to Case			15		$^\circ C/W$
	Thermal Shutdown	Junction Temperature		150		$^\circ C$
	Thermal Shutdown Hysteresis			25		$^\circ C$

LJ1117-5.0V Electrical Characteristics

Operating Conditions: $V_{IN} \leq 10V$, $T_J = 25^\circ C$, unless otherwise specified.

Symbol	Parameter	Conditions	Min	Typ	Max	Unit
V_{OUT}	Output Voltage	$I_{OUT} = 10mA$, $V_{IN} = 7.0V$ $10mA \leq I_{OUT} \leq 1A$, $6.5V \leq V_{IN} \leq 12V$	4.950 4.900	5.0 5.0	5.050 5.100	V
ΔV_{OUT}	Line Regulation	$I_{OUT} = 10mA$, $1.5V \leq V_{IN} - V_{OUT} \leq 10V$		1	10	mV
ΔV_{OUT}	Load Regulation	$V_{IN} - V_{OUT} = 2V$, $10mA \leq I_{OUT} \leq 1A$		1	15	mV
	Dropout Voltage	$\Delta V_{OUT} = 1\%$, $I_{OUT} = 0.1A$		1.00	1.1	V
		$\Delta V_{OUT} = 1\%$, $I_{OUT} = 0.5A$		1.08	1.18	V
		$\Delta V_{OUT} = 1\%$, $I_{OUT} = 1.0A$		1.15	1.25	V
I_{LIMIT}	Current Limit	$V_{IN} - V_{OUT} = 2V$	1.25	1.35		A
	Quiescent Current	$V_{IN} = V_{OUT} + 1.25V$		5	10	mA
	Ripple Rejection	$f = 120Hz$, $C_{OUT} = 22\mu F$ Tantalum, $V_{IN} - V_{OUT} = 3V$, $I_{OUT} = 1A$	60	75		dB
	Temperature Stability			0.5		%
	Long -Term Stability	$T_A = 125^\circ C$, 1000hrs		0.3		%
	RMS Output Noise (% of V_{OUT})	$T_A = 25^\circ C$, $10Hz \leq f \leq 10kHz$		0.003		%
θ_{JC}	Thermal Resistance, Junction to Case			15		$^\circ C/W$
	Thermal Shutdown	Junction Temperature		150		$^\circ C$
	Thermal Shutdown Hysteresis			25		$^\circ C$

Typical Performance Characteristics

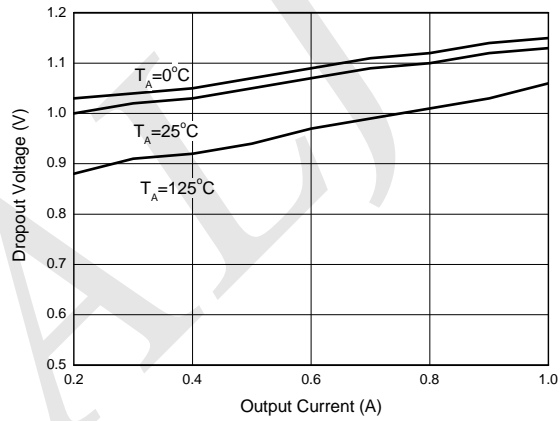

Figure 2: Dropout Voltage vs. Output Current

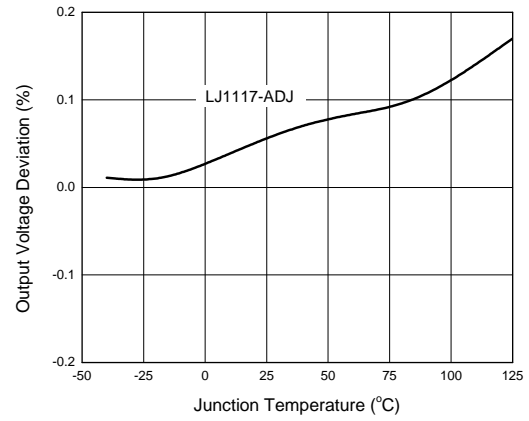

Figure 3: Load Regulation vs. Junction Temperature

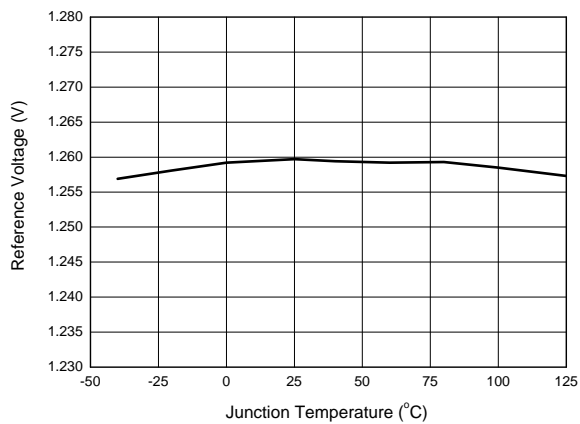

Figure 4: Reference Voltage vs. Junction Temperature

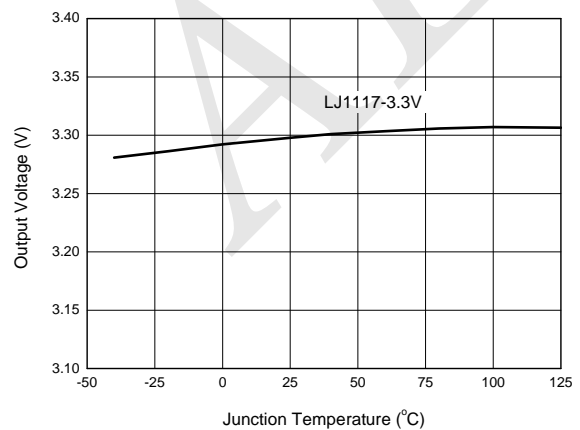

Figure 5: Output Voltage vs. Junction Temperature

Typical Performance Characteristics (Continued)

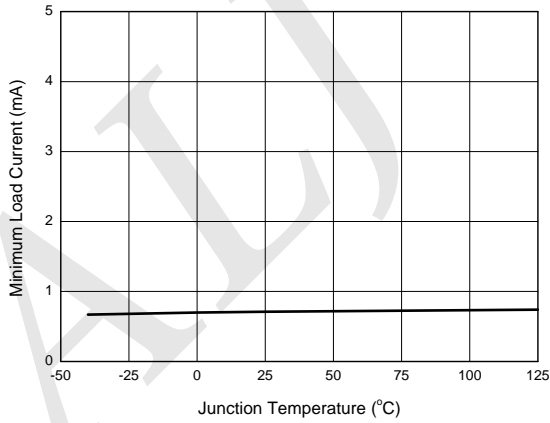

Figure 6. Minimum Load Current vs. Junction Temperature

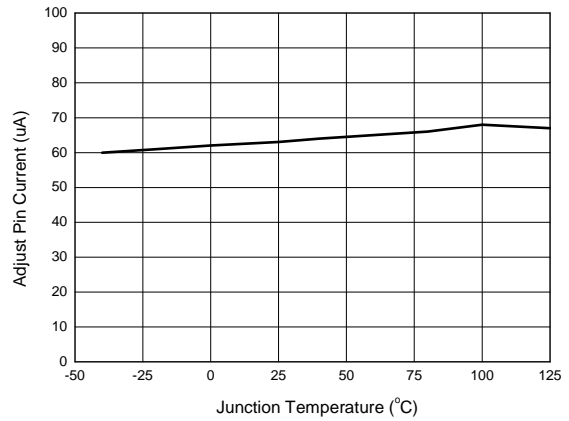

Figure 7. Adjust Pin Current vs. Temperature

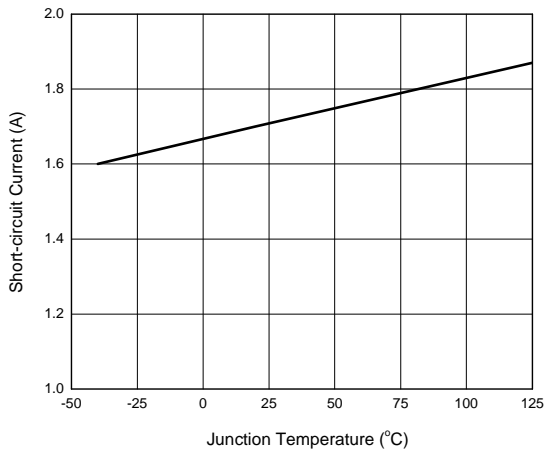

Figure 8. Short-Circuit Current vs. Junction Temperature

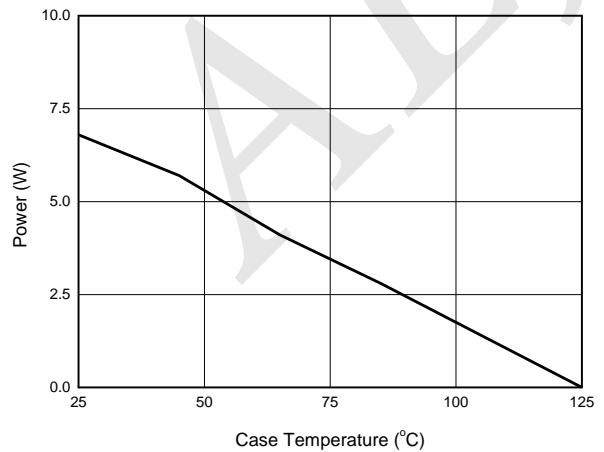

Figure 9. Maximum Power Dissipation

Typical Performance Characteristics (Continued)

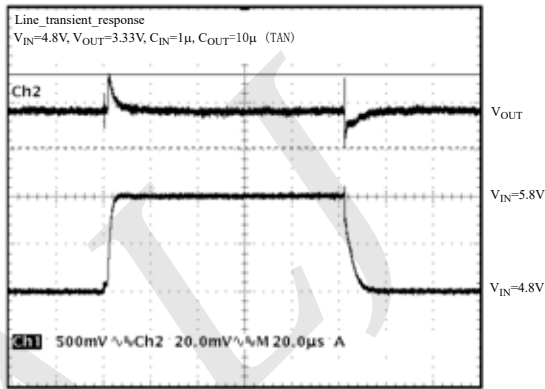

Figure 10. Line Transient Response

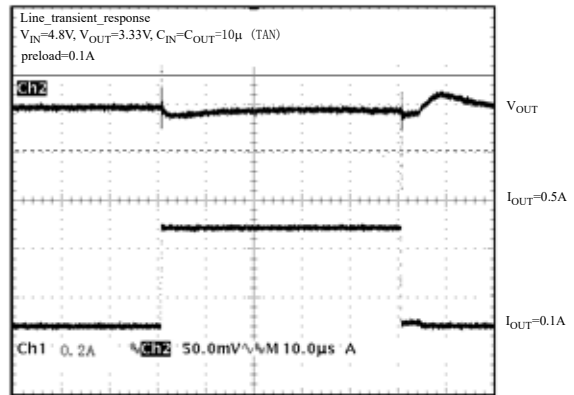

Figure 11. Load Transient Response

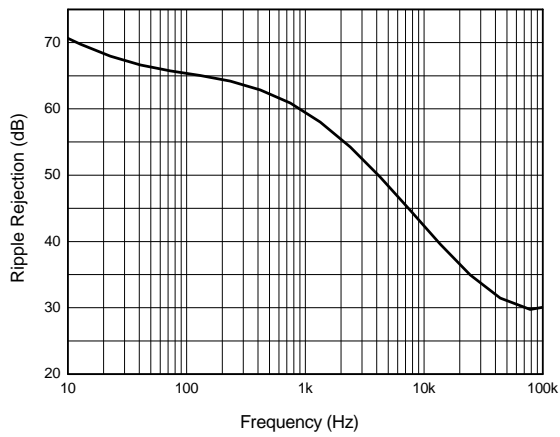

Figure 12. Ripple Rejection vs. Frequency

Typical Applications

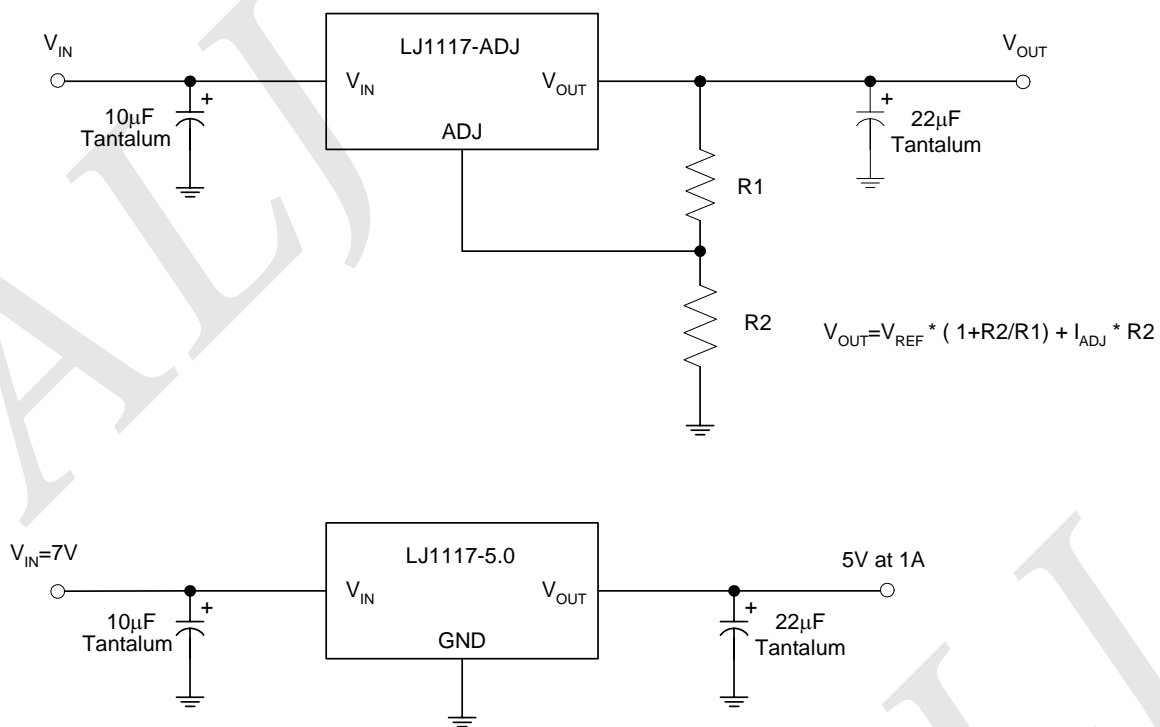

Figure 13. Typical Applications of LJ1117